

电机规格书 SPECIFICATION

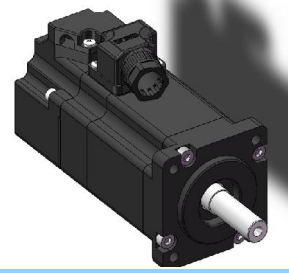

电机型号: 40M-R1630A5-E 匹配驱动器型号DCPC-09012-E
 MODEL: _____
 文档编号: _____
 FILE NUM.: _____

基本参数/BASIC PARAMETERS

额定功率(Kw): Rated Output(Kw):	0.05	极数: Number of Poles:	10
额定电压(V): Rated Voltage(V):	24	耐热等级: Vibration Class :	F
额定转速(rpm): Rated Speed(rpm):	3000	最高转速(rpm): Max. Speed(rpm):	5000
额定电流(A): Rated Current(A):	3.5±10%	瞬时最大电流(A): Instantaneous Max. Current(A):	11±10%
额定扭矩(N.m): Rated Torque(N.m):	0.159	瞬时最大扭矩(N.m): Instantaneous Peak Torque(N.m):	0.48
线电阻(Ω): Line Resistance(Ω):	0.98±10%(25℃)	线电感(mH): Line Inductance(mH):	0.61±10%
线反电势(V/krpm): Line Back EMF.(V/krpm):	3.11±10%	力矩系数(N.m/A): Torque Coefficient(N.m/A):	0.05±10%
转子惯量(Kg.m ² ×10 ⁻⁴): Rotor Moment of Inertia(Kg.m ² ×10 ⁻⁴):	0.036±10%	反馈元件: Feedback Component:	增量式 2500PPR
绝缘电阻(MΩ): Insulation Resistance(MΩ):	DC500V, >20MΩ	噪音(dB): Noise(dB):	≤60dB, 无异响/None Special Noise
工作时间: Time rating :	连续 Continuous	振动等级: Vibration Class :	V 15
环境温度: /Ambient Temperature :	0~+40℃	环境湿度: Ambient Humidity :	20~80%不结露 20~80% No Condensation
励磁方式: Excitation:	永磁式 Permanent Magnet	安装方式: Mounting :	法兰式 Flange Method
连接方式: Drive Method :	直接连接 Direct Drive	电机重量(Kg): Weight(Kg):	0.4±10%
保护方式: Enclosure :	全封闭, 自冷 IP65 (轴贯通部分除外) Totally Enclosed, Self-cooled, IP65 (except for shaft opening).		
旋转方向: Rotation Direction :	正转指令从负载侧看为逆时针方向旋转 Counterclockwise (CCW)		

※额定转矩表示安装在200×200×6的铝制散热板上且在环境温度40℃时的连续容许转矩值,电机引线电阻40mohm/500mm。/Rated torque is the continuous allowable torque at 40℃ with an AL heatsink of 200×200×6,the resistance of outgoing line is 40mohm/500mm.

连接器/CONNECTORS

1. 动力插座/Power Line Socket

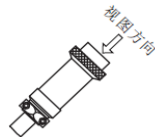

插座	M16-4A			
针号	1	2	3	4
定义	GND	U	V	W
颜色	黄绿	红	绿(蓝)	黑

2. 编码器插座/Encoder Socket

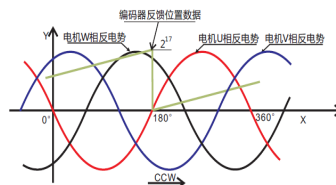
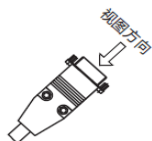
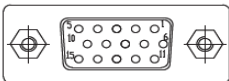

插座	三排 DB15 母插头														
针号	1	2	3	4	5	6	7	8	9	10	11	12	13	14	15
定义	NC	NC	U+	5V	0V	V+	Z-	Z+	W+	NC	B-	B+	A-	A+	NC
颜色			棕	红	黑	蓝	黄白	黄	橙		灰白	灰	绿白	绿	

Signal Format
CCW SHAFT ROTATION

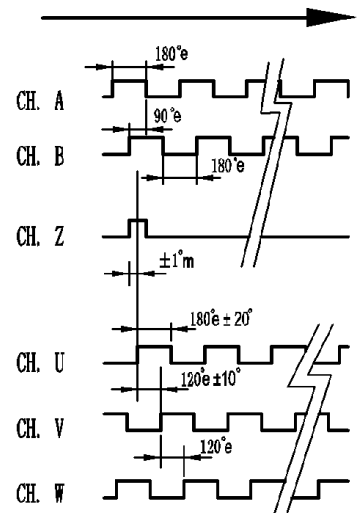

电机规格书 SPECIFICATION

转矩—转速特性/TORQUE-SPEED CHARACTERISTICS

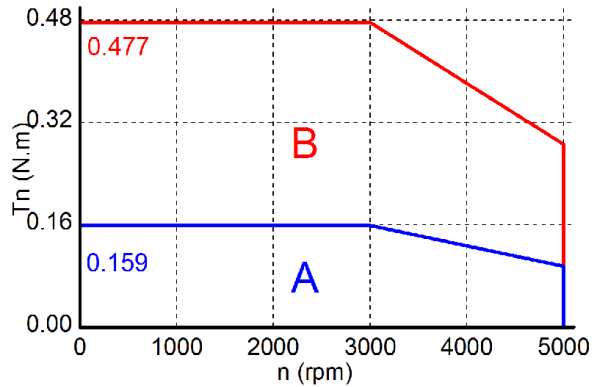

A:连续使用区域/Continuous Duty Zone
B:反复使用区域/Intermittent Duty Zone

过载特性曲线/OVERLOAD CHARACTERISTICS

工作时间在电机环境温度40°C以及热起动的条件下设定/The characteristics is measured in the warm-boot conditions at 40°C:

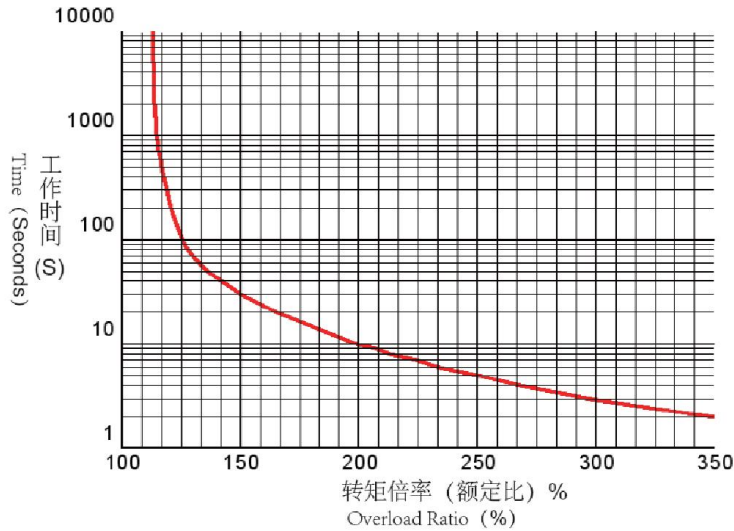

※1:上述过载特性并不保证100%以上输出的连续使用/The above characteristics do not supply 100% output for continuous running;

※2:使用时,请确保有效转矩在“转矩-转速特性”的连续使用范围内/Please make sure that the effective torque is in the range of T-N characteristics' continuous duty zone.

机械尺寸/External Dimensions(mm)

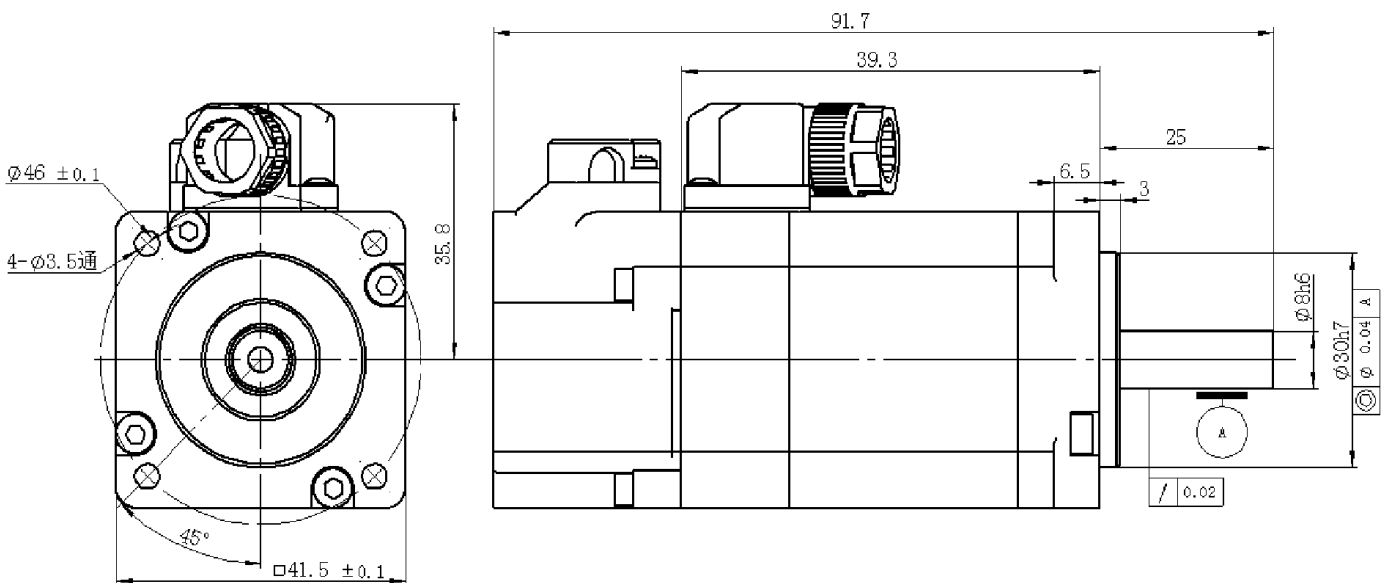

注:由于产品改良或规格变更,我们会适时对规格书进行更新,请关注相关信息,恕不另行通知。/Specification are subject to change without notice for ongoing product modification and improvement, please pay more attentions to the related information.